

► **Tape (Carrier) Dimensions**

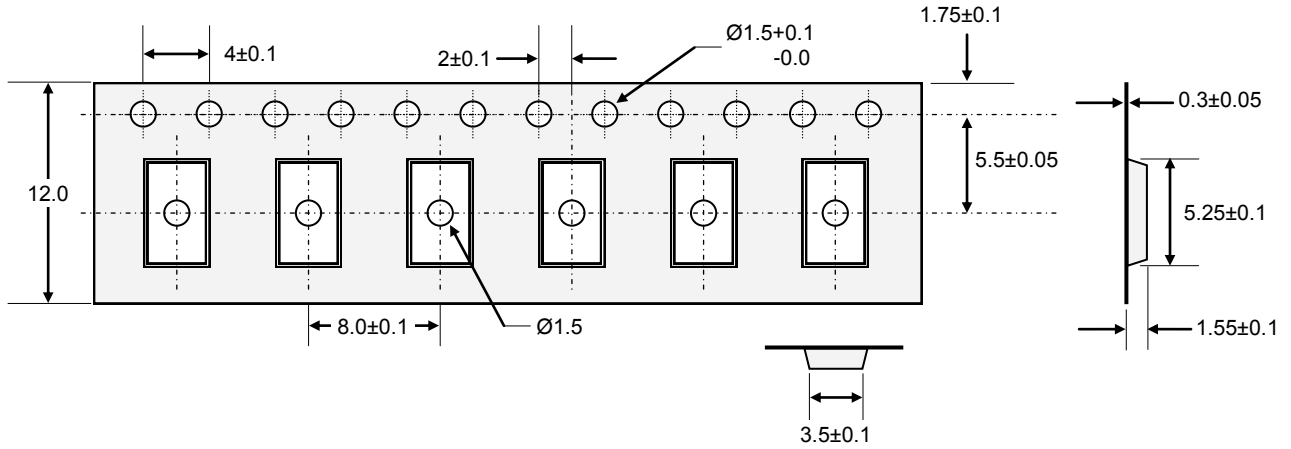

► **The Direction of Packing**

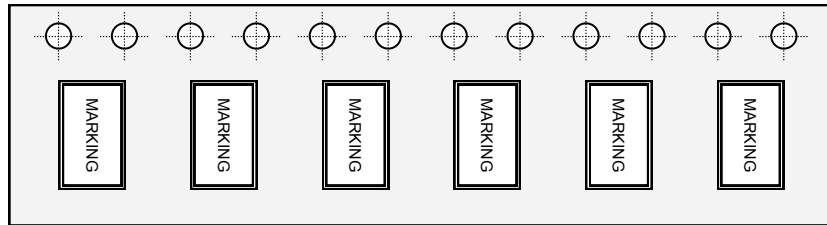

► **Reel Dimensions**

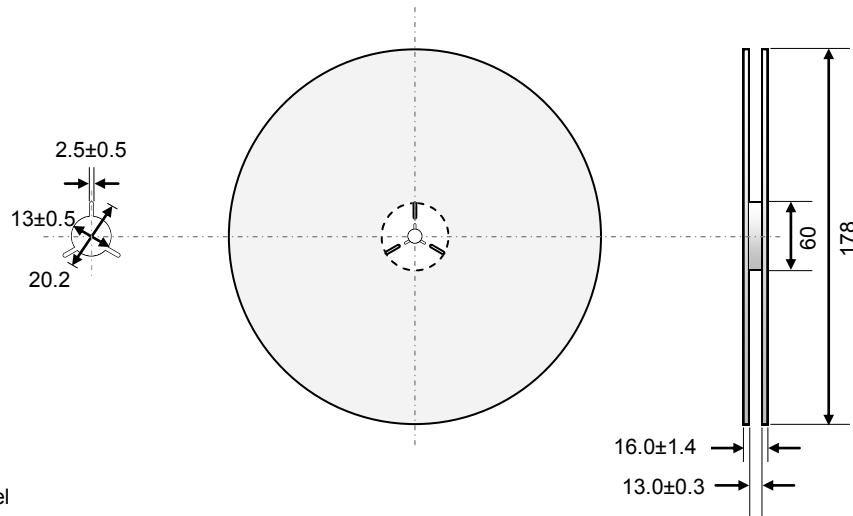

** Q'ty: 1000pcs/reel

Unit: mm

Transko Electronics, Inc reserves the right to make changes to the product (s), service (s), and specification (s) described herein without notice. See "Terms of Sale" for details on our website.