

## Resin Shielded Inductor SMD (6.0 X 6.0 X 4.5mm)

### FEATURES

- Resin Shielded construction
- Low DC Resistance
- Low Profile
- Halogen Free RoHS compliant

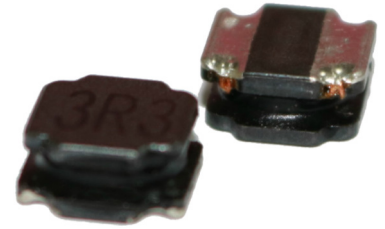

### SPECIFICATION

Part No.	Inductance (μH)	Tolerance	DC Resistance (mΩ ±30%)	Rated DC Current (A) Typ.	
				ΔL/L=30%	ΔT=40°C
TRSI6045F-1R0N	1.0	30%	12	12.2	6.50
TRSI6045F-1R8N	1.5	30%	17	9.60	5.60
TRSI6045F-2R2N	2.2	30%	19	8.80	5.00
TRSI6045F-3R3N	3.3	30%	24	7.50	4.30
TRSI6045F-4R7M	4.7	20%	31	6.70	3.90
TRSI6045F-5R1M	5.1	20%	33	6.00	3.50
TRSI6045F-6R8M	6.8	20%	43	5.30	3.20
TRSI6045F-8R2M	8.2	20%	50	4.60	2.70
TRSI6045F-100M	10	20%	57	4.50	2.70
TRSI6045F-150M	15	20%	80	3.40	2.20
TRSI6045F-220M	22	20%	125	3.00	1.90
TRSI6045F-270M	27	20%	160	2.50	1.40
TRSI6045F-330M	33	20%	180	2.30	1.30
TRSI6045F-470M	47	20%	245	1.90	1.20
TRSI6045F-680M	68	20%	330	1.60	1.00
TRSI6045F-101M	100	20%	600	1.30	0.80
TRSI6045F-331M	330	20%	1800	0.70	0.35
TRSI6045F-102M	1000	20%	6000	0.40	0.22

- Measurement frequency of Inductance value : at 100KHz, 0.25V
- Test equipment: CH1062A / CH1320

### DIMENSION

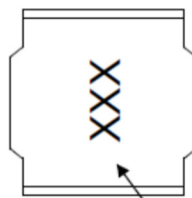
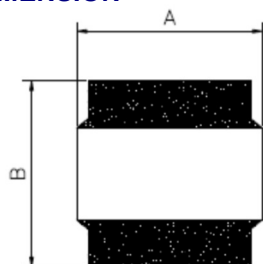

MARKING

### SOLDER PATTERN

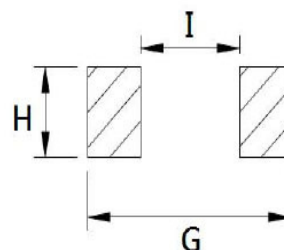

### SCHEMATIC

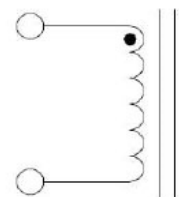

	A	B	C	G	H	I
mm	6.00 ±0.40	6.00 ±0.40	4.50 Max	6.30	6.30	2.00

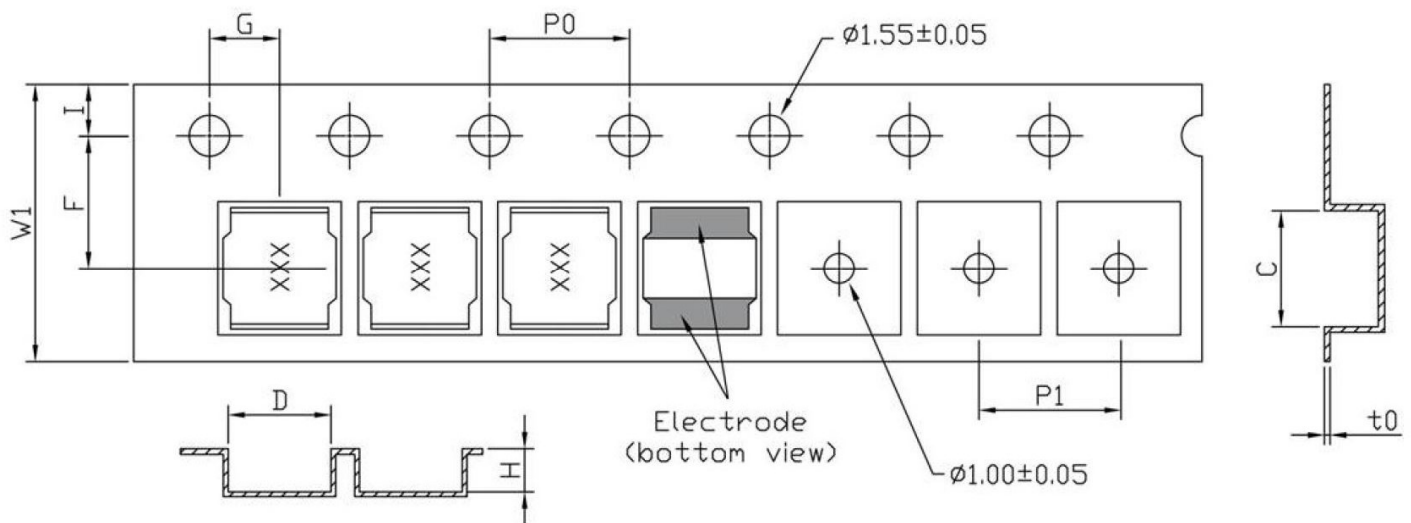
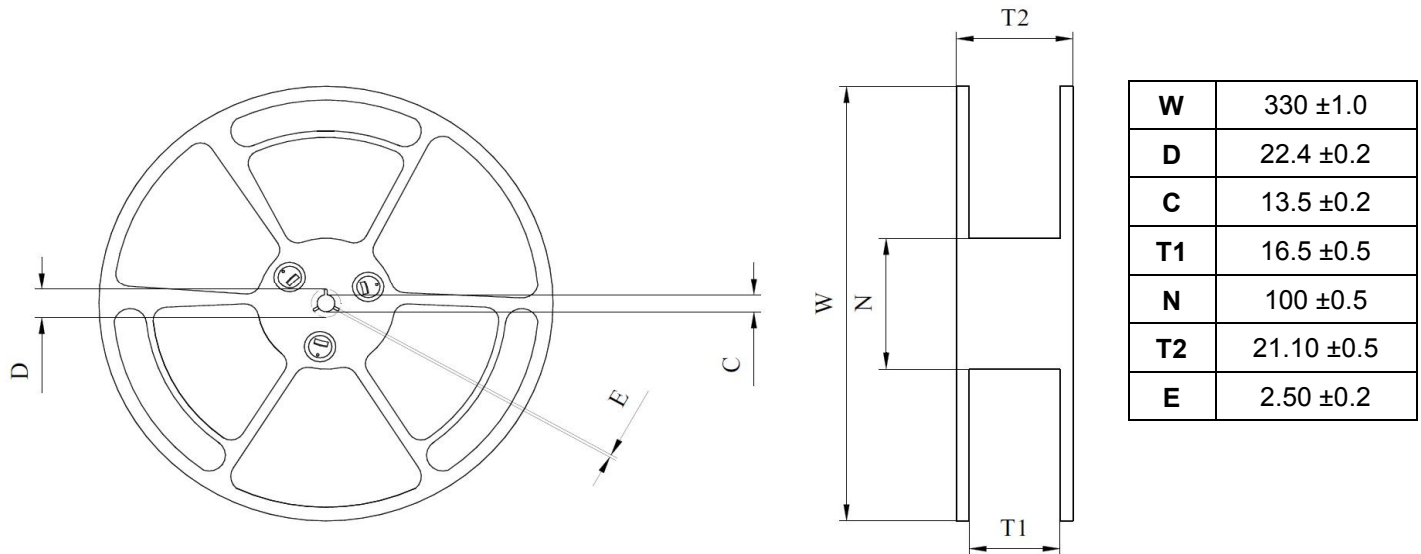
**REEL DIMENSIONS (1000 pcs per reel)**

<b>W1</b>	<b>I</b>	<b>F</b>	<b>P0</b>	<b>G</b>	<b>P1</b>	<b>C</b>	<b>t0</b>	<b>D</b>	<b>H</b>
$16.00 \pm 0.3$	$1.75 \pm 0.1$	$7.50 \pm 0.1$	$4.00 \pm 0.1$	$2.00 \pm 0.1$	$12.00 \pm 0.1$	$6.60 \pm 0.1$	$0.40 \pm 0.05$	$6.50 \pm 0.1$	$4.50 \pm 0.1$

## RELIABILITY TEST

1. Operating temperature range  
-40 TO + 125°C (Includes temperature when the coil is heated)
2. External appearance  
On visual inspection, the coil has no external defects.
3. Terminal strength  
After soldering. Between copper plate and terminals of coil. Push in two directions of X.Y withstanding at below conditions.  
Terminal should not peel off. (refer to figure at right)  
5.0N 60 sec.
4. Insulating resistance  
Over 100MΩ at 100V D.C. between coil and core.
5. Dielectric strength  
No dielectric breakdown at 100V D.C. for 1 minute between coil and core.
6. Temperature characteristics  
Inductance coefficient  $(0\sim 2,000)\times 10^{-6}/^{\circ}\text{C}$  (-25~+80°C)
7. Humidity characteristics (Moisture Resistance)  
Inductance deviation within  $\pm 5\%$ , after 96 hours in 90~95% relative humidity at  $40 \pm 2^{\circ}\text{C}$  and 1 hour drying under normal condition.
8. Vibration resistance  
Inductance deviation within  $\pm 5\%$ , after vibration for 1 hour. In each of three orientations at sweep vibration (10~55~10 Hz) with 1.5mm P-P amplitudes.
9. Shock resistance  
Inductance deviation within  $\pm 5\%$ , after being dropped once with  $981\text{m/s}^2$  (100G) shock attitude upon a rubber block method shock testing machine, in three different orientations.
10. Resistance to Soldering Heat: 260°C, 10 seconds (See recommend reflow)
11. Storage environment  
Temperature: 0°C~35°C; -40°~125°C after mounting  
Humidity Range: 50% ~ 70% RH
12. Use components within 12 months.  
If 12 months or more have elapsed, check solderability before use.

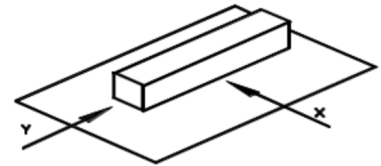

## LEAD-FREE HEAT ENDURANCE TEST

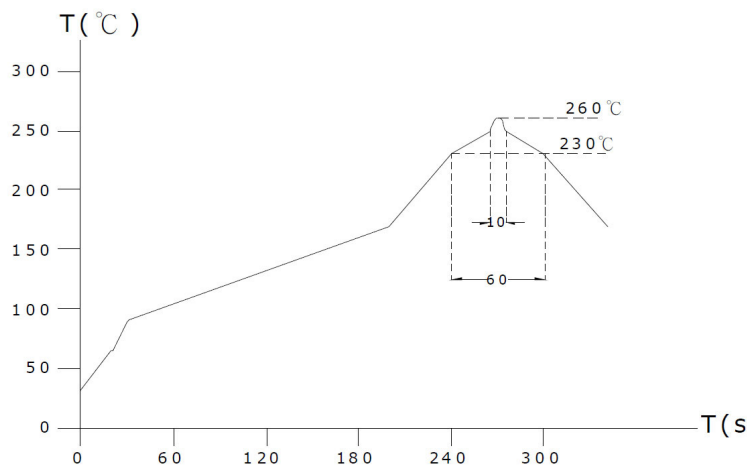

## LEAD-FREE RECOMMENDED REFLOW

