

Power Inductor SMD (10.10 X 10.0 X 3.8 mm)

FEATURES

- Magnetic shielded
- Halogen Free RoHS compliant



SPECIFICATION

Part No.	Inductance (μH)	Marking	DC Resistance Max. ($\text{m}\Omega$)	Rated DC Current (A) Typ.	
				$\Delta\text{L}/\text{L}=35\%$	$\Delta\text{T}=40^\circ\text{C}$
TPRH10D40F-1R5_	1.5	1R5	8.1	10.0	6.50
TPRH10D40F-2R2_	2.2	2R2	10.0	8.00	6.20
TPRH10D40F-2R5_	2.5	2R5	10.5	7.50	6.10
TPRH10D40F-3R3_	3.3	3R3	13.0	6.10	5.60
TPRH10D40F-4R7_	4.7	4R7	22.0	5.70	5.40
TPRH10D40F-5R2_	5.2	5R2	25.0	5.50	5.40
TPRH10D40F-7R0_	7.0	7R0	27.0	4.80	4.50
TPRH10D40F-100_	10	100	35.0	4.40	3.80
TPRH10D40F-150_	15	150	50.0	3.60	3.10
TPRH10D40F-220_	22	220	73.0	2.90	2.50
TPRH10D40F-330_	33	330	93.0	2.30	2.20
TPRH10D40F-470_	47	470	128	2.10	1.90
TPRH10D40F-680_	68	680	213	1.50	1.42
TPRH10D40F-101_	100	101	304	1.35	1.25
TPRH10D40F-151_	150	151	506	1.15	0.85
TPRH10D40F-221_	220	221	756	0.92	0.70
TPRH10D40F-331_	330	331	1090	0.70	0.52

- Measurement frequency of Inductance value : at 100KHz, 0.25V
- Test equipment: CH1062A / CH1320
- Inductance tolerance: Letter at end of part number: N = $\pm 30\%$; M = $\pm 20\%$

DIMENSION

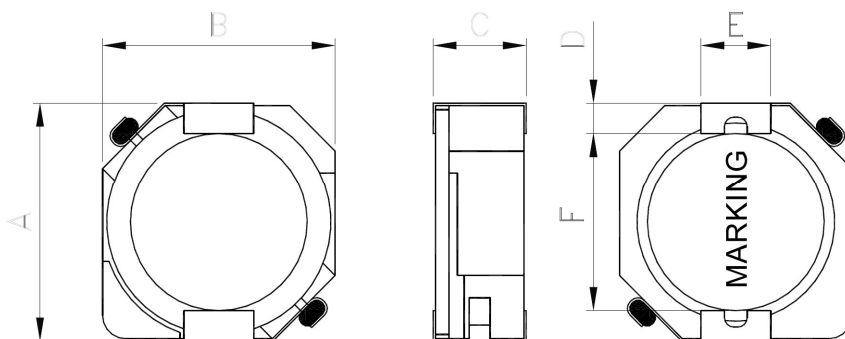

SOLDER PATTERN

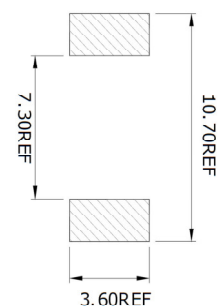

SCHEMATIC

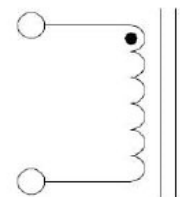

	A	B	C	D	E	F
mm	10.10 ± 0.30	10.00 ± 0.30	3.80 ± 0.20	1.20 REF	3.00 REF	8.00 MAX

LEAD-FREE HEAT ENDURANCE TEST

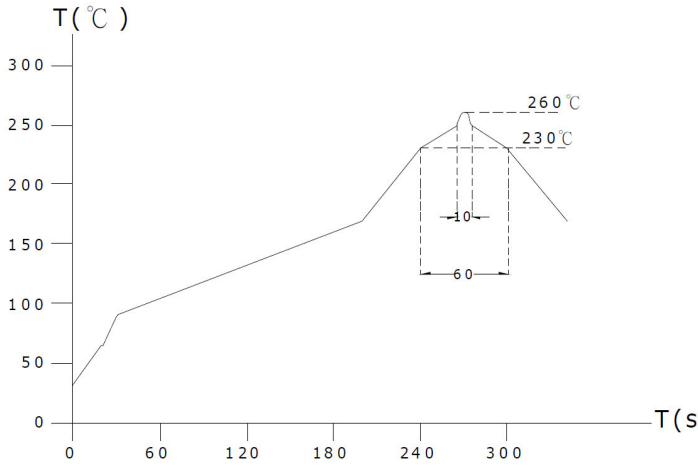

LEAD-FREE RECOMMENDED REFLOW

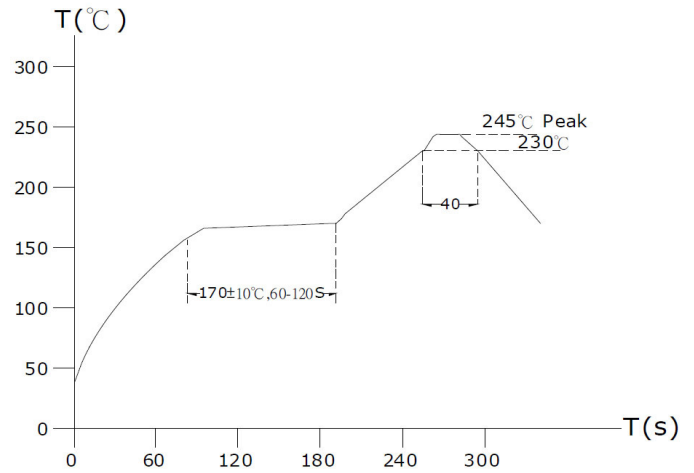

REEL DIMENSIONS (1000 pcs per reel)

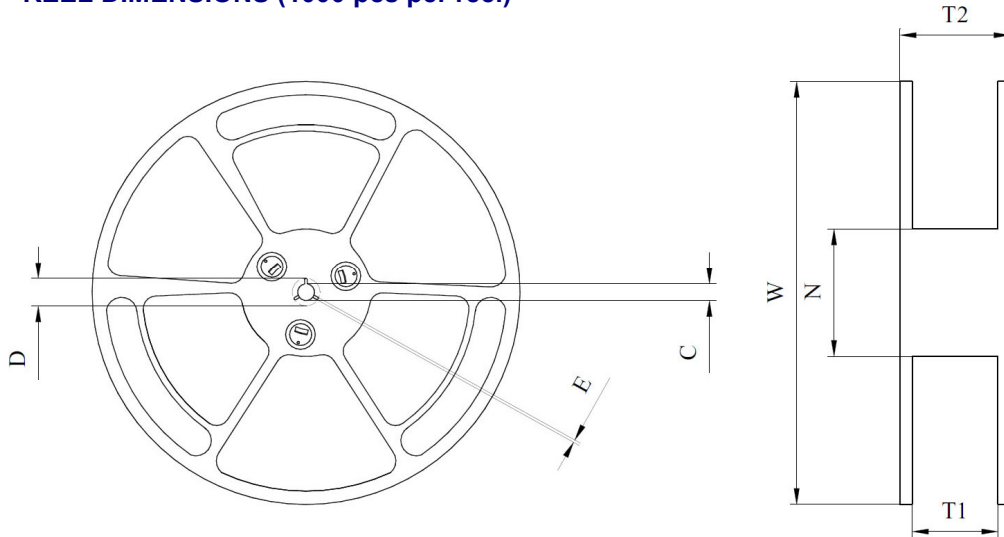

	mm
W	330±1.5
D	21.5+0.5/-0
C	13+0.5/-0.2
T1	24.5+0.5/-0
N	100±1.5
T2	29.5±0.4
E	2.00±0.5

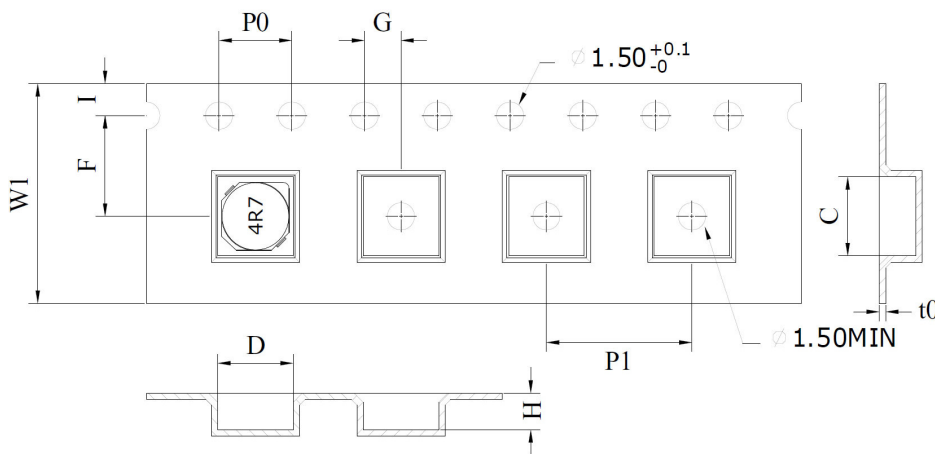

	mm
W1	24.00±0.3
I	1.75±0.1
F	11.5±0.1
P0	4.00±0.1
G	2.00±0.1
P1	16.00±0.1
C	10.50±0.1
t0	0.35±0.05
D	10.50±0.1
H	4.3±0.1

RELIABILITY TEST

1. Operating temperature range
-40 TO + 125°C (Includes temperature when the coil is heated)
2. External appearance
On visual inspection, the coil has no external defects.
3. Terminal strength
After soldering. Between copper plate and terminals of coil. Push in two directions of X.Y
withstanding at below conditions.
Terminal should not peel off. (refer to figure at right)
5.0N 60 sec.
4. Insulating resistance
Over 100MΩ at 100V D.C. between coil and core.
5. Dielectric strength
No dielectric breakdown at 100V D.C. for 1 minute between coil and core.
6. Temperature characteristics
Inductance coefficient $(0\sim 2,000)\times 10^{-6}/^{\circ}\text{C}$ (-25~+80°C)
inductance deviation within $\pm 5.0\%$, after 96 hours
7. Humidity characteristics (Moisture Resistance)
Inductance deviation within $\pm 5\%$, after 96 hours in 90~95% relative humidity at $40 \pm 2^{\circ}\text{C}$
and 1 hour drying under normal condition.
8. Vibration resistance
Inductance deviation within $\pm 5\%$, after vibration for 1 hour. In each of three orientations at
sweep vibration (10~55~10 Hz) with 1.5mm P-P amplitudes.
9. Shock resistance
Inductance deviation within $\pm 5\%$, after being dropped once with 981m/s^2 (100G) shock
attitude upon a rubber block method shock testing machine, in three different orientations.
10. Resistance to Soldering Heat: 260°C, 10 seconds (See recommended reflow)
11. Storage environment
Temperature: 0°C~35°C; -40°C~125°C (after mounting on PCB)
Humidity Range: 50% ~ 70% RH
12. Use components within 12 months.
If 12 months or more have elapsed, check solderability before use.

