

## Power Inductor SMD (10.10 X 10.10 X 4.50 mm)

### FEATURES

- High heat resistance, ideal for reflow
- High Current Capacity / Low DCR
- Halogen Free RoHS compliant
- Magnetically shielded

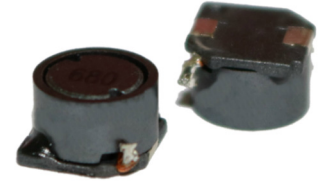

### SPECIFICATION

Part No.	Inductance ( $\mu\text{H} \pm 20\%$ )	DC Res. ( $\Omega \pm 20\%$ )	IDC
TCRB10145F-100M	10	0.0384	2.50
TCRB10145F-150M	15	0.0472	2.20
TCRB10145F-220M	22	0.0591	1.90
TCRB10145F-330M	33	0.0815	1.60
TCRB10145F-470M	47	0.100	1.40
TCRB10145F-680M	68	0.140	1.20
TCRB10145F-101M	100	0.200	1.00
TCRB10145F-151M	150	0.350	0.79
TCRB10145F-221M	220	0.470	0.65
TCRB10145F-331M	330	0.680	0.54
TCRB10145F-471M	470	1.030	0.47
TCRB10145F-681M	680	1.500	0.38
TCRB10145F-102M	1000	2.800	0.29
TCRB10145F-152M	1500	3.400	0.22

- IDC: Isat  $\Delta L/L \leq 30\%$  I rms  $\Delta T = 40^\circ\text{C}$
- Measurement frequency of Inductance value : at 1KHz, 0.25V
- Test equipment: CH1062A / CH1320 CH16502

### DIMENSION

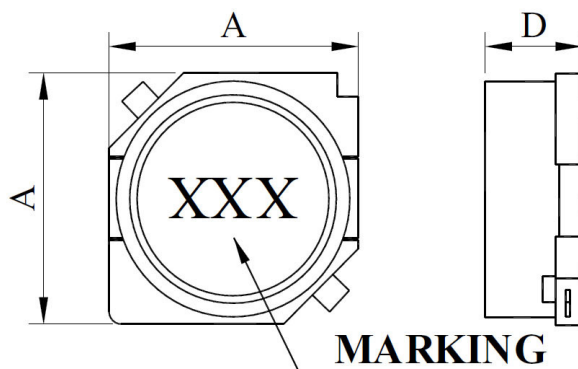

	mm
<b>A</b>	10.10 $\pm 0.30$
<b>C</b>	3.00 $\pm 0.10$
<b>D</b>	4.50 $\pm 0.30$
<b>E</b>	5.00 REF
<b>F</b>	2.00 REF

### SOLDER PATTERN

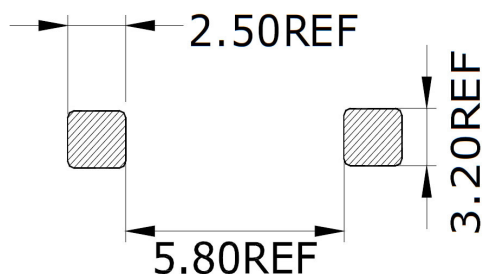

### SCHEMATIC

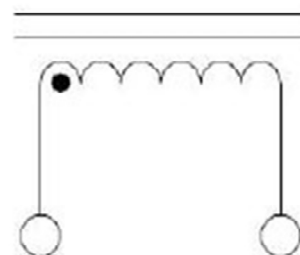

**REEL DIMENSIONS (500 pcs per reel)**

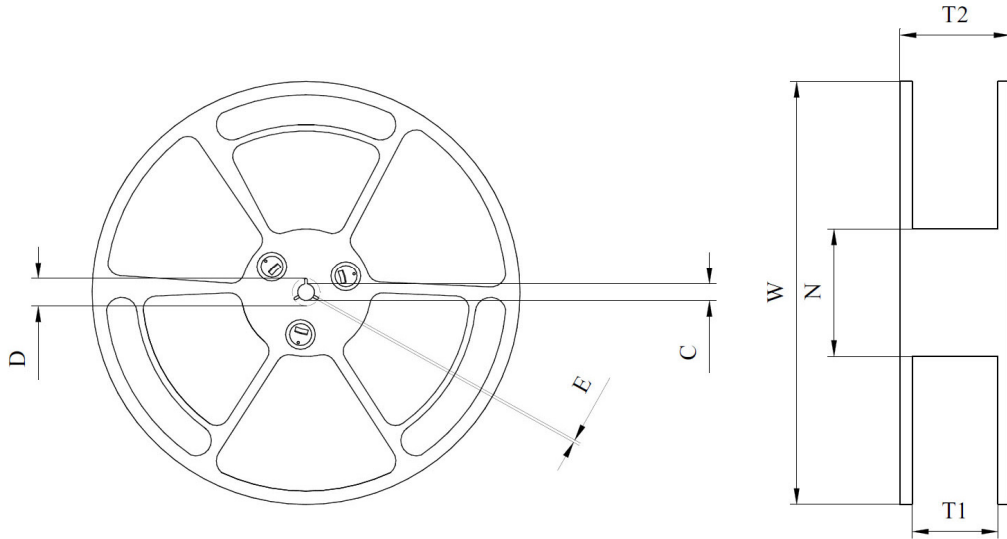

	mm
W	330±1.5
D	21.5+0.5/-0
C	13+0.5/-0.2
T1	24.5+0.5/-0
N	100±1.5
T2	29.5±0.4
E	2.00±0.5

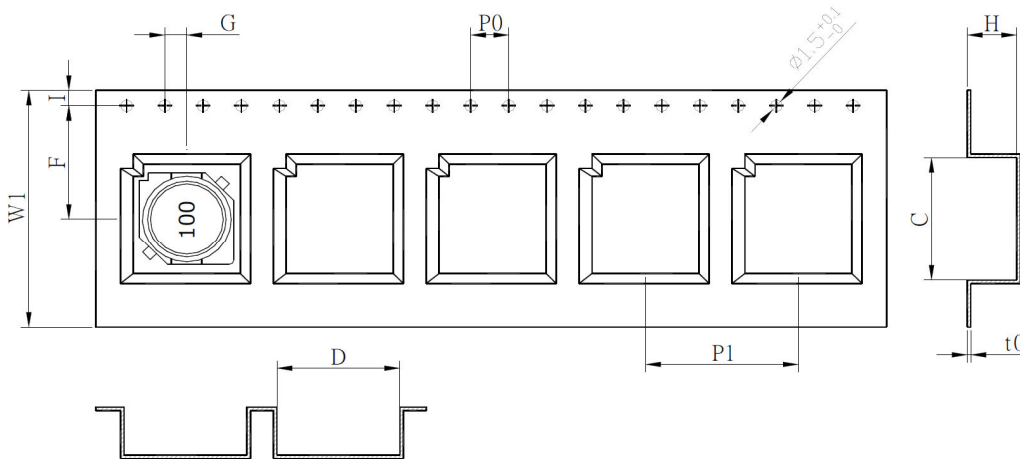

	mm
W1	24.00±0.3
I	1.75±0.1
F	11.50±0.1
P0	4.00±0.1
G	2.00±0.1
P1	16.00±0.1
C	10.80±0.1
t0	0.35±0.05
D	10.80±0.1
H	4.80±0.1

## RELIABILITY TEST

1. Operating temperature range  
-40 TO + 105°C (Includes temperature when the coil is heated)
2. External appearance  
On visual inspection, the coil has no external defects.
3. Terminal strength  
After soldering. Between copper plate and terminals of coil. Push in two directions of X.Y withstanding at below conditions.  
Terminal should not peel off. (refer to figure at right)  
5.0N 60 sec.
4. Insulating resistance  
Over 100MΩ at 100V D.C. between coil and core.
5. Dielectric strength  
No dielectric breakdown at 100V D.C. for 1 minute between coil and core.
6. Temperature characteristics  
Inductance coefficient  $(0\sim 2,000)\times 10^{-6}/^{\circ}\text{C}$  (-25~+80°C)  
inductance deviation within  $\pm 5.0\%$ , after 96 hours
7. Humidity characteristics (Moisture Resistance)  
Inductance deviation within  $\pm 5\%$ , after 96 hours in 90~95% relative humidity at  $40 \pm 2^{\circ}\text{C}$  and 1 hour drying under normal condition.
8. Vibration resistance  
Inductance deviation within  $\pm 5\%$ , after vibration for 1 hour. In each of three orientations at sweep vibration (10~55~10 Hz) with 1.5mm P-P amplitudes.
9. Shock resistance  
Inductance deviation within  $\pm 5\%$ , after being dropped once with  $981\text{m/s}^2$  (100G) shock attitude upon a rubber block method shock testing machine, in three different orientations.
10. Resistance to Soldering Heat: 260°C, 10 seconds (See recommended reflow)
11. Storage environment  
Temperature: 0°C~35°C; -40°C~105°C (after mounting on PCB)  
Humidity Range: 50% ~ 70% RH
12. Use components within 12 months.  
If 12 months or more have elapsed, check solderability before use.

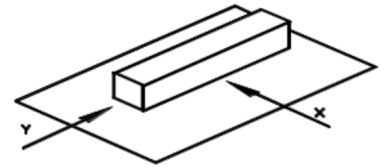

## LEAD-FREE HEAT ENDURANCE TEST

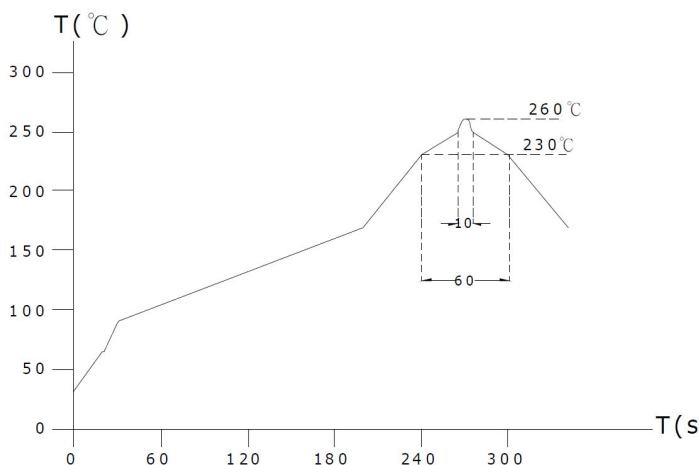

## LEAD-FREE RECOMMENDED REFLOW

